

Intel® X18-M/X25-M SATA Solid State Drive - 34 nm Product Line

Model Codes: SSDSA1M080G2XX, SSDSA2M080G2XX, SSDSA2J080G2XX, SSDSA1M160G2XX, SSDSA2M160G2XX

Product Codes: SSDSA2MH080G2XX, SSDSA1MH080G2XX, SSDSA2MJ080G2XX, SSDSA2MH160G2XX, SSDSA1MH160G2XX

Product Manual

- Available in 1.8" and 2.5" Form Factors
- Capacity: 80 GB and 160 GB
- Uses Intel NAND flash memory Multi-Level Cell (MLC) components
- Read and Write IOPS Specifications (Iometer* Queue Depth 32)
 - Random 4 KB Reads: Up to 35 K IOPS
 - Random 4 KB Writes:
 - 80 GB - Up to 6.6 K IOPS
 - 160 GB - Up to 8.6 K IOPS
- Bandwidth Performance Specifications
 - Sustained Sequential Read: Up to 250 MB/s
 - Sustained Sequential Write:
 - 80 GB - Up to 70 MB/s
 - 160 GB - Up to 100 MB/s
- Latency Specifications:
 - Read: 65 μ s
 - Write: 85 μ s
- Compatibility
 - Intel® SSD ToolBox
 - Intel® SSD Optimizer
 - Intel® Matrix Storage Manager
 - SATA Revision 2.6 compliant, compatible with SATA 1.5 Gb/s and 3 Gb/s interface rates
 - ATA/ATAPI-7 Compliant
 - SSD Enhanced S.M.A.R.T. ATA feature set
 - Native Command Queuing (NCQ) command set
- Certifications and Declarations
 - UL*
 - CE*
 - C-Tick*
 - BSMI*
 - KCC*
 - Microsoft* WHQL
 - VCCI*
 - SATA-IO*
- Power Management
 - 3.3 V (1.8") or 5 V (2.5") SATA Supply Rail
 - SATA Interface Power Management
 - OS-Aware Hot Plug/Removal
- Power Specifications
 - Active: 150 mW (TYP)
(MobileMark* 2007 Workload)
 - Idle: 75 mW (TYP)
- Temperature
 - Operating: 0° C to 70° C
 - Non-Operating: -55° C to 95° C
- Reliability
 - Read Error Rate (BER):
1 sector per 10¹⁶ bits read
 - Mean Time Between Failures (MTBF):
1,200,000 hours
- Shock, Operating and Non-operating:
1,500 G/0.5 msec
- Vibration
 - Operating: 2.17 G_{RMS} (5-700 Hz)
 - Non-operating: 3.13 G_{RMS} (5-800 Hz)
- Weight
 - 1.8" 5 mm Form Factor: 35 +/-2 grams
 - 2.5" 7 mm Form Factor: 76 +/-2 grams
 - 2.5" 9.5 mm Form Factor: 80 +/-2 grams
- Product Ecological Compliance
 - EU RoHS*
 - Halogen-free
- Data Set Management Command
 - Trim Attribute



Ordering Information

For ordering information on Intel® Solid State Drives please refer to the *Intel® High Performance SATA Solid-State Drives Product Selection Guide*.

INFORMATION IN THIS DOCUMENT IS PROVIDED IN CONNECTION WITH INTEL® PRODUCTS. NO LICENSE, EXPRESS OR IMPLIED, BY ESTOPPEL OR OTHERWISE, TO ANY INTELLECTUAL PROPERTY RIGHTS IS GRANTED BY THIS DOCUMENT. EXCEPT AS PROVIDED IN INTEL'S TERMS AND CONDITIONS OF SALE FOR SUCH PRODUCTS, INTEL ASSUMES NO LIABILITY WHATSOEVER, AND INTEL DISCLAIMS ANY EXPRESS OR IMPLIED WARRANTY, RELATING TO SALE AND/OR USE OF INTEL PRODUCTS INCLUDING LIABILITY OR WARRANTIES RELATING TO FITNESS FOR A PARTICULAR PURPOSE, MERCHANTABILITY, OR INFRINGEMENT OF ANY PATENT, COPYRIGHT OR OTHER INTELLECTUAL PROPERTY RIGHT. Intel products are not intended for use in medical, life saving, life sustaining, critical control or safety systems, or in nuclear facility applications.

Intel may make changes to specifications and product descriptions at any time, without notice.

Intel Corporation may have patents or pending patent applications, trademarks, copyrights, or other intellectual property rights that relate to the presented subject matter. The furnishing of documents and other materials and information does not provide any license, express or implied, by estoppel or otherwise, to any such patents, trademarks, copyrights, or other intellectual property rights.

Designers must not rely on the absence or characteristics of any features or instructions marked "reserved" or "undefined." Intel reserves these for future definition and shall have no responsibility whatsoever for conflicts or incompatibilities arising from future changes to them.

This Datasheet as well as the software described in it is furnished under license and may only be used or copied in accordance with the terms of the license. The information in this manual is furnished for informational use only, is subject to change without notice, and should not be construed as a commitment by Intel Corporation. Intel Corporation assumes no responsibility or liability for any errors or inaccuracies that may appear in this document or any software that may be provided in association with this document.

Except as permitted by such license, no part of this document may be reproduced, stored in a retrieval system, or transmitted in any form or by any means without the express written consent of Intel Corporation.

Contact your local Intel sales office or your distributor to obtain the latest specifications and before placing your product order.

Copies of documents which have an order number and are referenced in this document, or other Intel literature may be obtained by calling 1-800-548-4725 or by visiting Intel's website at <http://www.intel.com>.

Intel and Intel logo are trademarks or registered trademarks of Intel Corporation or its subsidiaries in the United States and other countries.

*Other names and brands may be claimed as the property of others. Copyright © 2009, Intel Corporation. All Rights Reserved.

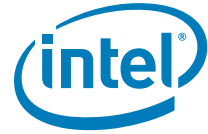

Contents

- 1.0 Introduction** 5
 - 1.1 Product Overview 5
 - 1.2 Block Diagram 6
 - 1.3 Architecture 6
- 2.0 Certifications and Declarations** 6
- 3.0 Product Specifications** 7
 - 3.1 Capacity 7
 - 3.2 Performance 7
 - 3.3 Electrical Characteristics 8
 - 3.3.1 Supply Voltage 8
 - 3.3.2 Power Consumption 8
 - 3.4 Environmental Conditions 9
 - 3.4.1 Temperature 9
 - 3.4.2 Shock and Vibration 9
 - 3.4.3 Acoustics 9
 - 3.4.4 Electromagnetic Immunity 10
 - 3.5 Reliability 10
 - 3.5.1 Nonrecoverable Read Errors 11
 - 3.5.2 Mean Time Between Failure 11
 - 3.5.3 Power On/Off Cycles 11
 - 3.5.4 Minimum Useful Life 11
 - 3.5.5 Insertion Cycles 11
- 4.0 Mechanical Information** 11
 - 4.1 1.8" 5 mm Intel X18-M SATA SSD 11
 - 4.2 2.5" 7 mm Intel X25-M SATA SSD 13
 - 4.3 2.5" 9.5 mm Intel X25-M SATA SSD 14
- 5.0 Pin and Signal Descriptions** 15
 - 5.1 Pin Locations 15
 - 5.1.1 1.8" Pin Locations 15
 - 5.1.2 2.5" Pin Locations 16
 - 5.2 Signal Description Table 16
 - 5.3 Hot Plug Support 18
- 6.0 Command Sets** 18
 - 6.1 ATA Commands 18
 - 6.1.1 ATA General Feature Command Set 18
 - 6.1.1.1 IDENTIFY DEVICE Data 19
 - 6.1.2 Power Management Command Set 21
 - 6.1.3 Security Mode Feature Set 22
 - 6.1.4 SMART Command Set 22
 - 6.1.5 Host Protected Area Command Set 22
 - 6.1.6 48-Bit Address Command Set 23
 - 6.1.7 Device Configuration Overlay Command Set 23
 - 6.1.8 General Purpose Log Command Set 23
 - 6.2 SATA Commands 23
 - 6.2.1 Software Settings Preservation 24
 - 6.2.2 Native Command Queuing 24
 - 6.2.3 Device Initiated Power Management (DIPM) 24
- 7.0 References** 24

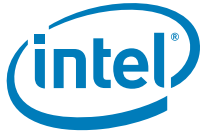

8.0 Additional Product Information	25
9.0 Terms and Acronyms	25
10.0 Revision History	27

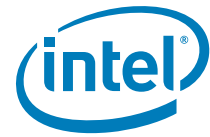

1.0 Introduction

The Intel® X18-M/X25-M SATA Solid State Drive (SSD) delivers leading performance in industry standard 1.8" and 2.5" form factors while simultaneously improving system responsiveness for client applications over standard rotating drive media or hard disk drives. By combining Intel's leading 34nm NAND flash memory technology with our innovative high performance controller, Intel delivers its next generation SSD for native Serial Advanced Technology Attachment (SATA) hard disk drive drop-in replacement with enhanced performance, reliability, ruggedness and power savings.

Since there are no rotating platters, moving heads, or fragile actuators, unnecessary delays due to spin-up time or positional seek time that can slow down the storage subsystem significantly, are absent. The Intel X18-M/X25-M SATA SSD enables fast read/write access times and a significant I/O and throughput performance improvement as compared to rotating media or hard disk drives.

This document describes the specifications of our new addition to the Solid State Drive product family: Intel X18-M/X25-M SATA SSD - 34 nm product line in both the 1.8" and 2.5" form factors.

1.1 Product Overview

The Intel X18-M/X25-M SATA SSDs primarily target SATA based client PCs, highly rugged mobile client devices, as well as thin and light, mini/sub-notebooks. Key attributes include high performance, low power, increased system responsiveness, high reliability and enhanced ruggedness as compared to standard mobile SATA hard drives. Intel X18-M/X25-M SATA SSDs are available in 1.8" and 2.5" form factors that are electrically, mechanically, and software compatible with existing 1.8" and 2.5" Serial ATA slots and cables. Our flexible design allows interchangeability with existing mobile hard drives based on the SATA interface standard.

1.2 Block Diagram

Figure 1. Block Diagram

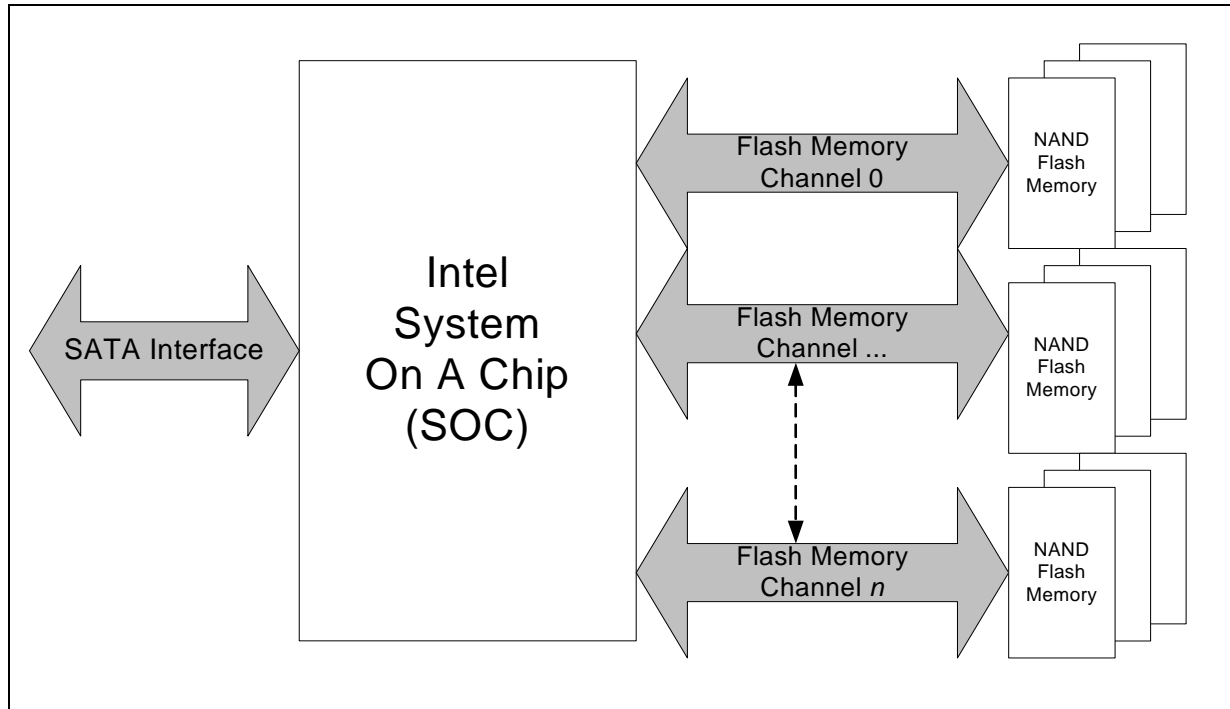

1.3 Architecture

The Intel X18-M/X25-M SATA SSDs utilize a cost effective System on a Chip (SOC) design to manage a full SATA 3 Gb/s bandwidth with the host while managing multiple flash memory devices on multiple channels internally.

2.0 Certifications and Declarations

Table 1. Device Certifications and Declarations

Certification	Description
CE Compliant	Indicates conformity with the essential health and safety requirements set out in European Directives Low Voltage Directive and EMC Directive.
UL Certified	Underwriters Laboratories, Inc. Component Recognition UL60950-1.
C-Tick Compliant	Compliance with the Australia/New Zealand Standard AS/NZS3548 and Electromagnetic Compatibility (EMC) Framework requirements of the Australian Communication Authority (ACA).
BSMI Compliant	Compliance to the Taiwan EMC standard "Limits and methods of measurement of radio disturbance characteristics of information technology equipment, CNS 13438 Class B."

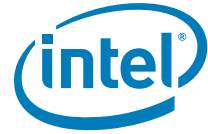
**Table 1. Device Certifications and Declarations (Continued)**

Certification	Description
KCC	Compliance with paragraph 1 of Article 11 of the Electromagnetic Compatibility control Regulation and meet the Electromagnetic Compatibility (EMC) Framework requirements of the Radio Research Laboratory (RRL) Ministry of Information and Communication Republic of Korea.
Microsoft WHQL	Microsoft Windows Hardware Quality Labs
RoHS Compliant	Restriction of Hazardous Substance Directive
VCCI	Voluntary Control Council for Interface to cope with disturbance problems caused by personal computers or facsimile.
SATA-IO	Indicates certified logo program from Serial ATA International Organization

3.0 Product Specifications

3.1 Capacity

Table 2. User Addressable Sectors

Unformatted Capacity	Total User Addressable Sectors in LBA Mode
80 GB	156,301,488
160 GB	312,581,808

Notes:

- 1 GB = 1,000,000,000 Byte. LBA count shown represents total user storage capacity and will remain the same throughout the life of the drive.
- The total usable capacity of the Intel SSD may be less than the total physical capacity of the Intel SSD. This is due to the fact that a small portion of the Intel SSD capacity is used for NAND flash management and maintenance purposes.
- 1 Sector = 512 Byte.
- IDEMA LBA standards adopted in calculating the LBA count.

3.2 Performance

Table 3. Maximum Sustained Read and Write Bandwidth

Access Type	MB/s
Sequential Read	Up to 250
Sequential Write	80 GB: Up to 70
	160 GB: Up to 100

Notes:

- Performance measured using Iometer with queue depth equal to 32.
- 1 MB/sec = 1,048,576 bytes/sec was used in measuring sequential performance.

**Table 4. Latency Specifications**

Type	Average Latency
Read	65 μ s (TYP)
Write	85 μ s (TYP)
Power On to Ready	1.50 s (TYP)

Notes:

1. Write Cache Enabled.
2. Device measured using Iometer.
3. Power On To Ready time is measured from power rail rising edge to the first DRDY issued from the drive.
4. Read/Write latency measured on sequential 4 K transfers with QD=1.

Table 5. Random Read/Write Input/Output Operations Per Second

Access Type	IOPS
4K Read	Up to 35,000
4K Write	80GB: Up to 6,600
	160 GB: Up to 8,600

Notes:

1. Performance measured using Iometer with queue depth set to 32.
2. Write Cache enabled.
3. Measurements are performed on 8 GB of LBA range.

3.3 Electrical Characteristics

3.3.1 Supply Voltage

Table 6. Operating Voltage

Description	Min	Max	Unit
Operating Voltage for 3.3 V (+/- 5%)	3.14	3.47	V
Operating Voltage for 5 V (+/- 5%)	4.75	5.25	V

3.3.2 Power Consumption

Table 7. Typical Power Consumption

Mode	Typ	Unit
Active	150	mW
Idle	75	mW

Note: Active power measured during execution of MobileMark* 2007 with DIPM (Device Initiated Power Management) enabled.

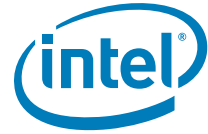

3.4 Environmental Conditions

3.4.1 Temperature

Table 8. Temperature Related Specifications

	Mode	Min	Typ	Max	Unit
Case Temperature	Operating	0		70	°C
	Non-Operating	-55		95	°C
Temperature Gradient	Operating		20		°C/hr *
	Non-Operating		30		°C/hr *
Humidity	Operating	5		95	%
	Non-Operating	5		95	%

Notes:

1. Temperature measured on the top side of SSD case, centered for width and one inch from SATA connector edge.
2. Temperature gradient measured without condensation.

3.4.2 Shock and Vibration

Table 9. Shock and Vibration Specifications

	Mode	Timing/Frequency	Max
Shock ¹	Operating	at 0.5 msec	1,500 G
	Non-Operating	at 0.5 msec	1,500 G
Vibration ²	Operating	5-700 Hz	2.17 G
	Non-Operating	5-800 Hz ³	3.13 G

Notes:

1. Shock specifications assumes that the SSD is mounted securely with the input vibration applied to the drive mounting screws. Stimulus may be applied in the X, Y or Z axis. Shock specification is measured using RMS value.
2. Vibration specifications assumes that the SSD is mounted securely with the input vibration applied to the drive mounting screws. Stimulus may be applied in the X, Y or Z axis. The measured specification is in root mean squared form. Vibration specification is measured using RMS value.
3. Sine wave sweeping 1 oct/min.

3.4.3 Acoustics

The SSD has no moving or noise-emitting parts; therefore, it produces negligible sound (0 dB) in all modes of operation.



3.4.4 Electromagnetic Immunity

Electromagnetic Immunity tests assume the SSD is properly installed in the representative host system. The drive will operate properly without errors or degradation in performance when subjected to radio frequency (RF) environments referenced in the international specifications noted in these following documents:

Table 10. Electromagnetic Immunity and Compliance Specifications

Title	Description	Region for which conformity declared
IEC 60950-1 - 1st Edition	Safety of Information Technology Equipment	International
UL/CSA 60950-1 Edition	Safety of Information Technology Equipment	USA/Canada
EN 60950-1:2001	Safety of Information Technology Equipment	European Union
cTick	The EMC Framework (Radio Communication Act 1992)	Australia
FCC, 47 CFR Part 15	Radio Frequency Devices - Subpart B - Unintentional Radiators B	USA
ICES-003 Issue 4 - February 2004	Interface-Causing Equipment Standards - Digital Apparatus B	Canada
BSMI CNS14348; CNS14266	Bureau of Standards, Metrology and Inspection, Ministry of Economic Affairs Electromagnetic Compatibility	Taiwan
EN 55022 and 55024	EN 55022:2006 Information Technology Equipment - Radio Disturbance Characteristics B; EN 55024:1998 +A1:2001 +A2:2003 Information Technology Equipment - Immunity Characteristics	European Union
CISPR 22:2005	Information Technology Equipment - Radio Disturbance Characteristics B	International
EN61000	EN61000-3-2 Information Technology Equipment - Harmonics Characteristics; EN61000-3-3 Information Technology Equipment - Flicker Characteristics	European Union
VCCI CISPR22 B	Information Technology Equipment - Radio Disturbance Characteristics	Japan
KCC	Framework Act on Telecommunications and Radio Waves Act	Korea

3.5 Reliability

Table 11. Reliability Specifications

Parameter	Value
Nonrecoverable read errors	1 sector in 10 ¹⁶ bits read, max
Mean Time between Failure (MTBF)	1,200,000 hours
Power On/Off Cycles	50,000 cycles
Minimum Useful Life	5 years
Insertion Cycles	250 cycles

Note: Please refer to sections 3.5.1 to 3.5.4 for more details on these reliability specifications.

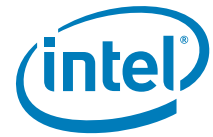

3.5.1 Nonrecoverable Read Errors

The nonrecoverable read error rate will not exceed one sector in the specified number of bits read. In the extremely unlikely event of a nonrecoverable read error, the drive will report it as a read failure to the host; the sector in error is considered corrupt and is not returned to the host.

3.5.2 Mean Time Between Failure

The Mean Time Between Failure (MTBF) is estimated based on Telcordia methodology and demonstrated through Reliability Demonstration Test (RDT).

3.5.3 Power On/Off Cycles

Defined as power being removed from the drive, and then restored. Most host systems remove power from the drive when entering suspend and hibernate as well as on a system shutdown.

3.5.4 Minimum Useful Life

The drive will have a minimum of 5 years of useful life under typical client workloads with up to 20 GB of host writes per day.

3.5.5 Insertion Cycles

The drive will support up to 250 insertion/removal cycles on SATA/power cable.

4.0 Mechanical Information

4.1 1.8" 5 mm Intel X18-M SATA SSD

The following figure shows the physical package information for the 5 mm height 1.8" Intel X18-M SATA SSD.

Figure 2. Dimensions for Intel X18-M SATA SSD 1.8" 5 mm Form Factor

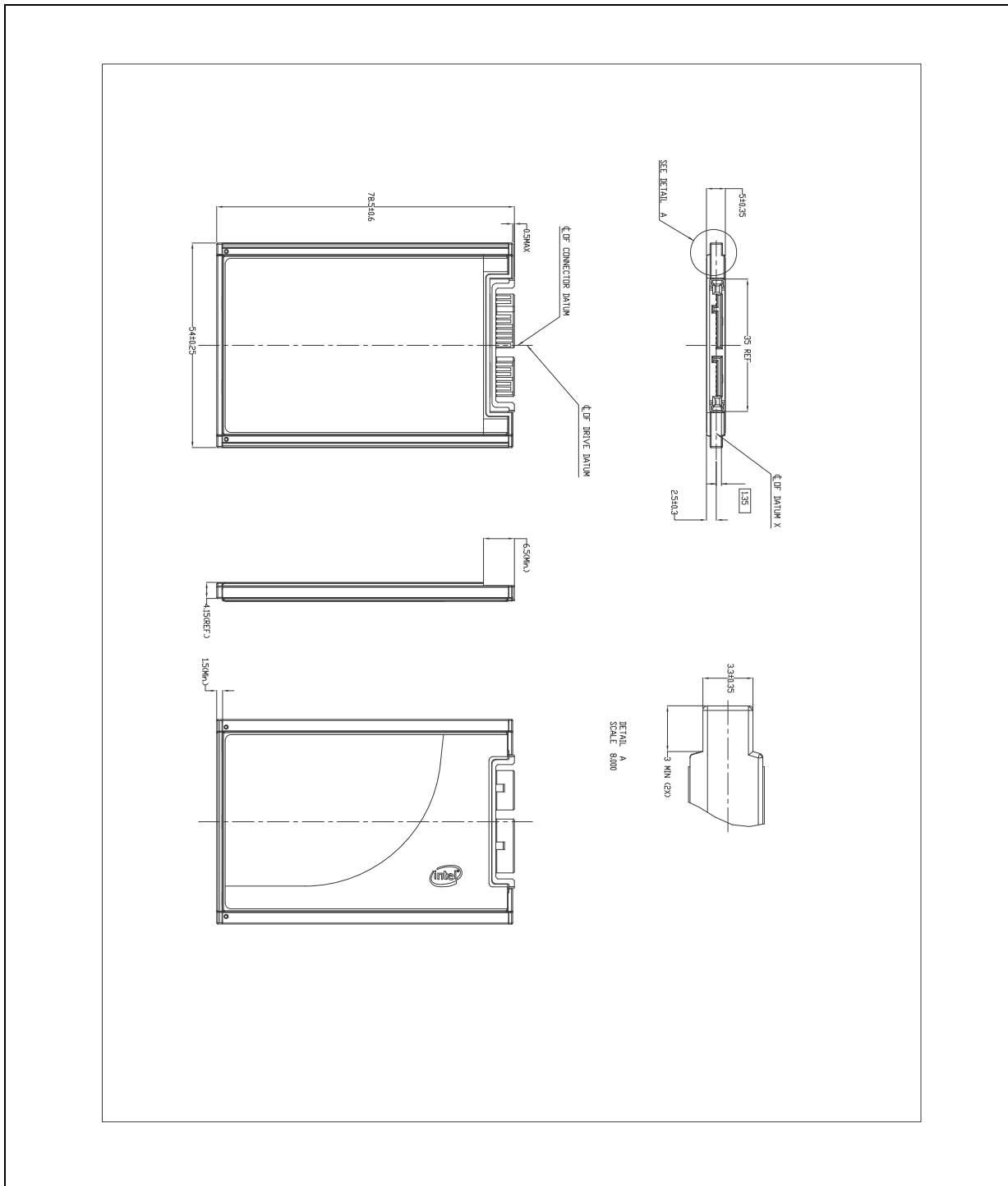

Notes:

1. Connector Outline: The 1.8" Intel X18-M SATA SSD connector is compliant to the SATA Rev 2.6 specifications.
2. Connector Location: The 1.8" Intel X18-M SATA SSD connector is compliant to the micro SATA SFF-8144 specification.
3. All dimensions are in millimeters.

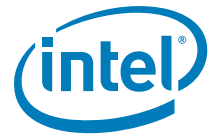

4.2 2.5" 7 mm Intel X25-M SATA SSD

The following figure shows the physical package information for the 7 mm height 2.5" Intel X25-M SATA SSD.

Figure 3. Dimensions for Intel X25-M SATA SSD 2.5" 7 mm Form Factor

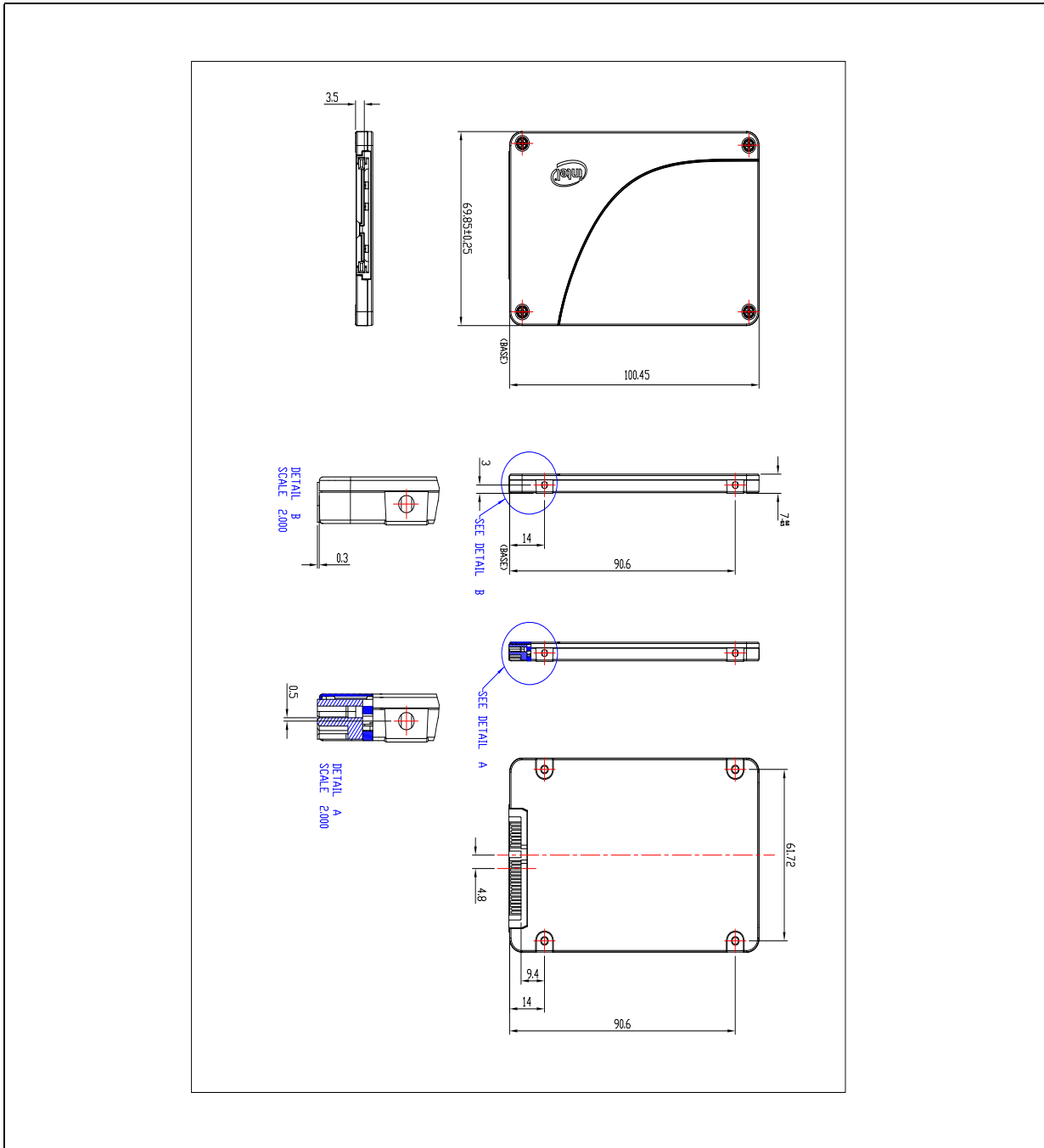

Note: All dimensions are in millimeters.

4.3 2.5" 9.5 mm Intel X25-M SATA SSD

The following figure shows the physical package information for the 9.5 mm height 2.5" Intel X25-M SATA SSD.

Figure 4. Dimensions for Intel X25-M SATA SSD 2.5" 9.5 mm Form Factor

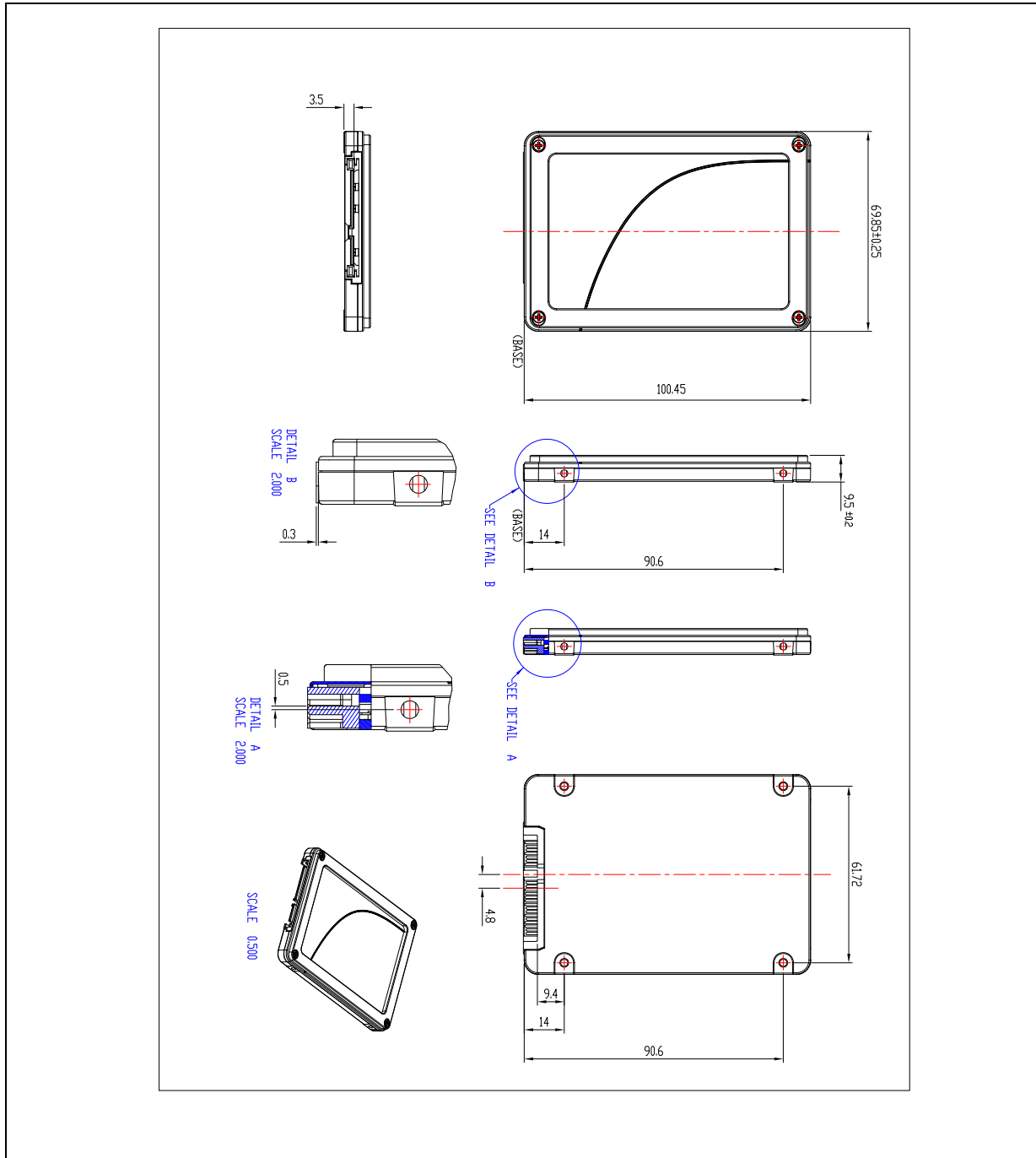

Note: All dimensions are in millimeters.

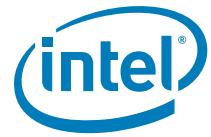

5.0 Pin and Signal Descriptions

This section identifies the pin locations and signal descriptions of the Intel X18-M/X25-M SATA SSDs.

5.1 Pin Locations

5.1.1 1.8" Pin Locations

Figure 5. Layout of Signal and Power Segment Pins

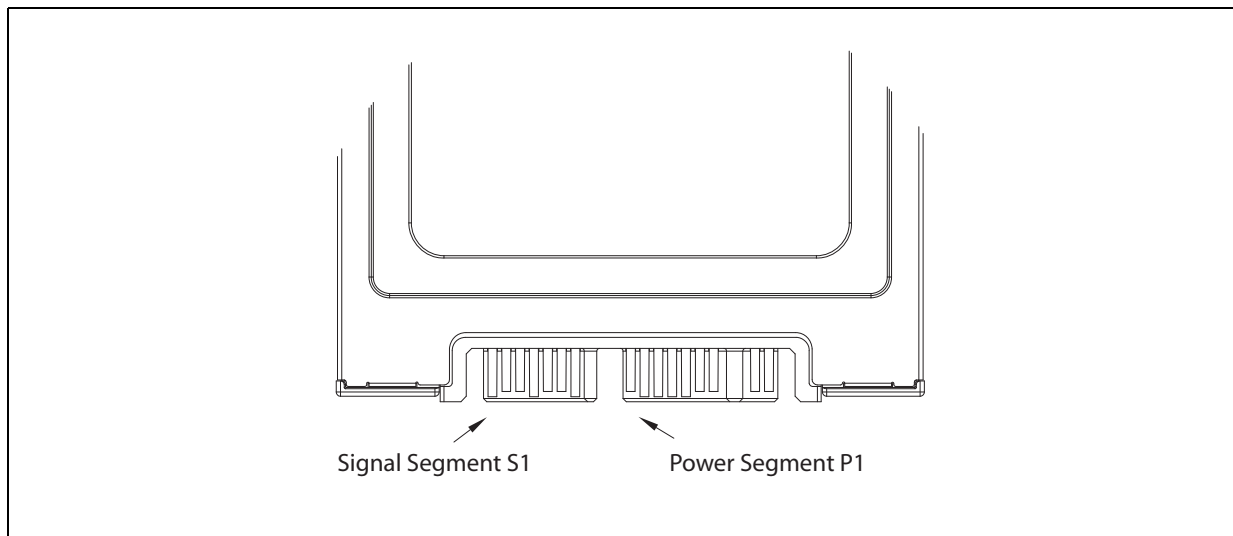

5.1.2 2.5" Pin Locations

Figure 6. Layout of Signal and Power Segment Pins

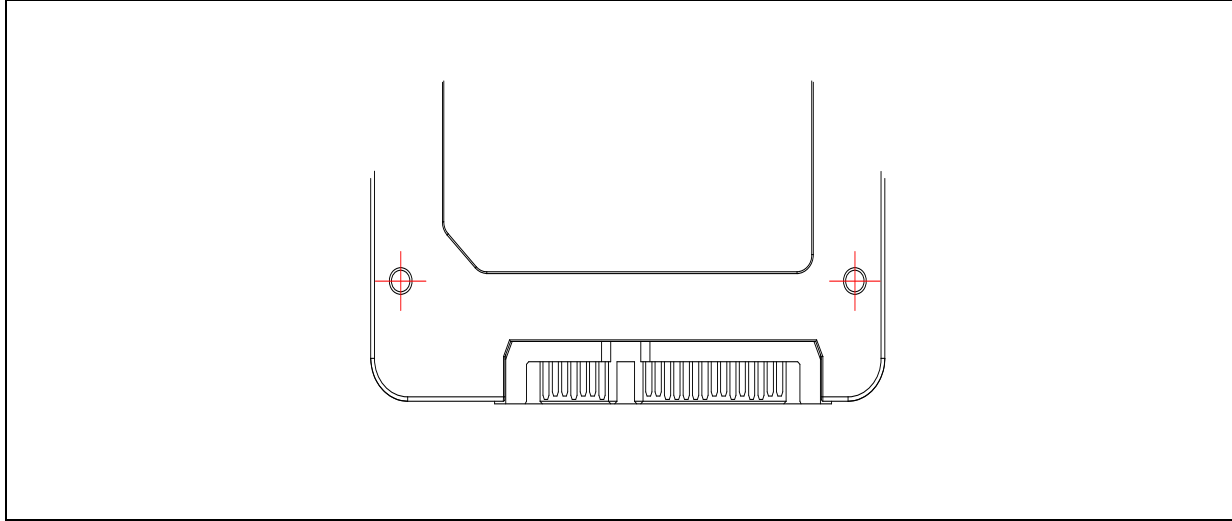

Note: 2.5" connector supports in-built latching capability.

5.2 Signal Description Table

Table 12. Serial ATA Connector Pin Signal Definitions for 1.8" and 2.5" Form Factors

Pin	Function	Definition
S1	Ground	1st mate
S2	A+	Differential signal pair A
S3	A-	
S4	Ground	1st mate
S5	B-	Differential signal pair B
S6	B+	
S7	Ground	1st mate

Note: Key and spacing separate signal and power segments.

Table 13. Serial ATA Power Pin Definitions for 1.8" Form Factor

Pin	Function	Definition	Mating Order ¹
P1	V ₃₃	3.3 V Power ²	2nd Mate
P2	V ₃₃	3.3 V Power, pre-charge ²	2nd Mate
P3	Ground ³		1st Mate
P4	Ground ³		1st Mate
P5	V ₅	5 V Power. Not connected ⁴	1st Mate



Table 13. Serial ATA Power Pin Definitions for 1.8" Form Factor (Continued)

Pin	Function	Definition	Mating Order ¹
P6	V ₅	5 V Power. Not connected ⁴	2nd Mate
P7	V ₅	5V Power, Pre-charge	2nd Mate
Key	Key	NC	NC
P8	Optional	Manufacturing Test Pin ⁵	2nd Mate
P9	Optional	Manufacturing Test Pin ⁵	2nd Mate

Notes:

- All mate sequences assume zero angular offset between connectors.
- P1 and P2 are internally connected to one another within the device.
- Ground connectors P3 and P4 may contact before the other 1st mate pins in both the power and signal connectors to discharge ESD in a suitably configured backplane connector.
- P5 and P6 are not connected internal to the device. The host may put 5V on these pins.
- P8 and P9 should not be connected by the host.

Table 14. Serial ATA Power Pin Definitions for 2.5" Form Factor

Pin ¹	Function	Definition	Mating Order
P1	Not connected ²	(3.3 V Power)	
P2	Not connected ²	(3.3 V Power)	
P3	Not connected ²	(3.3 V Power. pre-charge)	2nd Mate
P4	Ground ^{3, 4}		1st Mate
P5	Ground ³		1st Mate
P6	Ground ³		1st Mate
P7	V ₅ ^{3, 5}	5 V Power	1st Mate
P8	V ₅ ^{3, 5}	5 V Power	2nd Mate
P9	V ₅ ^{3, 5}	5 V Power	2nd Mate
P10	Ground ³		1st Mate
P11	DAS ⁶	Device Activity Signal ⁶	2nd Mate
P12	Ground ^{3, 4}		1st Mate
P13	V ₁₂ ⁷	12 V Power. Not used.	1st Mate
P14	V ₁₂ ⁷	12 V Power. Not used.	2nd Mate
P15	V ₁₂ ⁷	12 V Power. Not used.	2nd Mate

Notes:

- All pins are in a single row, with a 1.27 mm (0.050") pitch.
- Pins P1, P2 and P3 are connected together, although they are not connected internally to the device. The host may put 3.3 V on these pins.
- The mating sequence are:
 - the ground pins P4-P6, P10, P12 and the 5v power pin P7.
 - the signal pins and the rest of the 5V power pins P8-P9.
- Ground connectors P4 and P12 may contact before the other 1st mate pins in both the power and signal connectors to discharge ESD in a suitably configured backplane connector.
- Power pins P7, P8, and P9 are internally connected to one another within the device.
- The host may ground P11 if it is not used for Device Activity Signal (DAS).
- Pins P13, P14 and P15 are connected together, although they are not connected internally to the device. The host may put 12 V on these pins.



5.3 Hot Plug Support

Hot Plug insertion and removal are supported in the presence of a proper connector and appropriate operating system (OS) support as described in the SATA 2.6 specification. This product supports Asynchronous Signal Recovery and will issue an unsolicited COMINIT when first mated with a powered connector to guarantee reliable detection by a host system without hardware device detection.

6.0 Command Sets

6.1 ATA Commands

The Intel X18-M/X25-M SATA SSDs support all the mandatory ATA commands defined in the ATA/ATAPI-7 specification.

6.1.1 ATA General Feature Command Set

The Intel X18-M/X25-M SATA SSDs support the ATA General Feature command set (non-PACKET), which consists of

- EXECUTE DEVICE DIAGNOSTIC
- FLUSH CACHE
- IDENTIFY DEVICE
- READ DMA
- READ SECTOR(S)
- READ VERIFY SECTOR(S)
- SEEK
- SET FEATURES
- WRITE DMA
- WRITE SECTOR(S)
- READ MULTIPLE
- SET MULTIPLE MODE
- WRITE MULTIPLE

The Intel X18-M/X25-M SATA SSDs also support the following optional commands:

- READ BUFFER
- WRITE BUFFER
- NOP
- DOWNLOAD MICROCODE

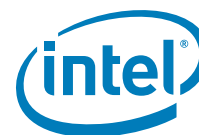

6.1.1.1 IDENTIFY DEVICE Data

The following table details the sector data returned after issuing an IDENTIFY DEVICE command.

Table 15. Returned Sector Data

Word	F = Fixed V = Variable X = Both	Default Value	Description
0	F	0040h	General configuration bit-significant information
1	X	3FFFh	Obsolete - Number of logical cylinders (16,383)
2	V	C837h	Specific configuration
3	X	0010h	Obsolete - Number of logical heads (16)
4-5	X	0h	Retired
6	X	003Fh	Obsolete - Number of logical sectors per logical track (63)
7-8	V	0h	Reserved for assignment by the CompactFlash Association
9	X	0h	Retired
10-19	F	Varies	Serial number (20 ASCII characters)
20-21	X	0h	Retired
22	X	0h	Obsolete
23-26	F	Varies	Firmware revision (8 ASCII characters)
27-46	F	Varies	Model number (Intel Solid State Drive)
47	F	8010h	7:0—Maximum number of sectors transferred per interrupt on MULTIPLE commands
48	F	0h	Reserved
49	F	2F00h	Capabilities
50	F	4000h	Capabilities
51-52	X	0h	Obsolete
53	F	0007h	Words 88 and 70: 64 Valid
54	X	3FFFh	Obsolete - Number of logical cylinders (16,383)
55	X	0010h	Obsolete - Number of logical heads (16)
56	X	003Fh	Obsolete - Number of logical sectors per logical track (63)
57-58	X	00FBFC10h	Obsolete
59	F	0110h	Number of sectors transferred per interrupt on MULTIPLE commands
60-61	F	0950F8B0h (80 GB)	Total number of user addressable sectors
		FFFFFFFFh (160 GB)	
62	X	0h	Obsolete
63	F	0007h	Multi-word DMA modes supported/selected
64	F	0003h	PIO modes supported
65	F	0078h	Minimum Multiword DMA transfer cycle time per word
66	F	0078h	Manufacturer's recommended Multiword DMA transfer cycle time
67	F	0078h	Minimum PIO transfer cycle time without flow control
68	F	0078h	Minimum PIO transfer cycle time with IORDY flow control
69	F	4020h	Command overlap and queuing

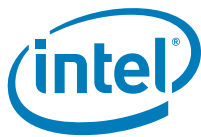

Table 15. Returned Sector Data (Continued)

Word	F = Fixed V = Variable X = Both	Default Value	Description
70	F	0h	Reserved (for future command overlap and queuing)
71-74	F	0h	Reserved for the IDENTIFY PACKET DEVICE command.
75	F	001Fh	Queue depth
76	F	0506h	Serial ATA capabilities
77	F	0h	Reserved for future Serial ATA definition
78	F	0048h	Serial ATA features supported
79	V	0040h	Serial ATA features enabled
80	F	00FCh	Major Version Number
81	F	001Ah	Minor Version Number
82	F	746Bh	Command set supported.
83	F	7D01h	Command sets supported.
84	F	6163h	Command set/feature supported extension.
85	V	7469h	Command set/feature enabled.
86	V	BC01h	Command set/feature enabled.
87	V	6163h	Command set/feature default.
88	V	407Fh	Ultra DMA Modes
89	F	0001h	Time required for security erase unit completion
90	F	0001h	Time required for Enhanced security erase completion
91	V	0h	Current advanced power management value
92	V	FFFEh	Master Password Revision Code
93	F	0h	Hardware reset result. The contents of bits (12:0) of this word shall change only during the execution of a hardware reset.
94	V	0h	Vendor's recommended and actual acoustic management value.
95	F	0h	Stream Minimum Request Size
96	V	0h	Streaming Transfer Time - DMA
97	V	0h	Streaming Access Latency - DMA and PIO
98-99	F	0h	Streaming Performance Granularity
100-103	V	0950F8B0h (80 GB)	Maximum user LBA for 48-bit Address feature set.
		12A19EB0h (160 GB)	
104	V	0h	Streaming Transfer Time - PIO
105	F	0008h	Maximum number of 512-byte blocks of LBA Range Entries per DATA SET MANAGEMENT command
106	F	4000h	Physical sector size / logical sector size
107	F	0h	Inter-seek delay for ISO-7779 acoustic testing in microseconds
108-111	F	Varies	Unique ID
112-115	F	0h	Reserved for world wide name extension to 128 bits
116	V	0h	Reserved for technical report-
117-118	F	0h	Words per Logical Sector

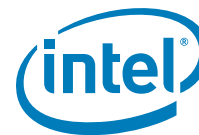

Table 15. Returned Sector Data (Continued)

Word	F = Fixed V = Variable X = Both	Default Value	Description
119	F	401Ch	Supported Settings
120	F	401Ch	Command Set/Feature Enabled/Supported
121-126	F	0h	Reserved
127	F	0h	Removable Media Status Notification feature set support
128	V	0021h	Security status
129-159	X	0h	Vendor specific
160	F	0h	CompactFlash Association (CFA) power mode 1
161-168	X	0h	Reserved for assignment by the CFA
169	X	0001h	Data set management trim attribute support
170- 175	X	0h	Reserved for assignment by the CFA
176-205	V	0h	Current media serial number
206-216	F	0h	Reserved
217	F	0001h	Nominal Media Rotational Rate
218-221	F	0h	Reserved
222	F	101F	Reserved
223-233	F	0h	Reserved
234		0001h	Reserved
235		01F0h	Reserved
236-254	F	0h	Reserved
255	X	Varies	Integrity word (Checksum and Signature)

Notes:

1. **F = Fixed.** The content of the word is fixed and does not change. For removable media devices, these values may change when media is removed or changed.
2. **V = Variable.** The state of at least one bit in a word is variable and may change depending on the state of the device or the commands executed by the device.
3. **X = F or V.** The content of the word may be fixed or variable.

6.1.2 Power Management Command Set

The Intel X18-M/X25-M SATA SSD supports the Power Management command set, which consists of

- CHECK POWER MODE
- IDLE
- IDLE IMMEDIATE
- SLEEP
- STANDBY
- STANDBY IMMEDIATE

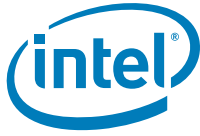

6.1.3 Security Mode Feature Set

The Intel X18-M/X25-M SATA SSD supports the Security Mode command set, which consists of

- SECURITY SET PASSWORD
- SECURITY UNLOCK
- SECURITY ERASE PREPARE
- SECURITY ERASE UNIT
- SECURITY FREEZE LOCK
- SECURITY DISABLE PASSWORD

6.1.4 SMART Command Set

The Intel X18-M/X25-M SATA SSDs support the SMART command set, which consists of

- SMART ENABLE OPERATIONS
- SMART DISABLE OPERATIONS
- SMART ENABLE/DISABLE AUTOSAVE
- SMART RETURN STATUS

The Intel X18-M/X25-M SATA SSDs also support the following optional commands:

- SMART EXECUTE OFF-LINE IMMEDIATE
- SMART READ DATA
- SMART READ LOG
- SMART WRITE LOG

6.1.5 Data Set Management Command Set

The Intel X25-V SATA SSDs support the Data Set Management command set Trim attribute, which consists of

- DATA SET MANAGEMENT EXT

6.1.5 Host Protected Area Command Set

The Intel X18-M/X25-M SATA SSDs support the Host Protected Area command set, which consists of

- READ NATIVE MAX ADDRESS
- SET MAX ADDRESS
- READ NATIVE MAX ADDRESS EXT
- SET MAX ADDRESS EXT

The Intel X18-M/X25-M SATA SSDs also support the following optional commands:

- SET MAX SET PASSWORD
- SET MAX LOCK

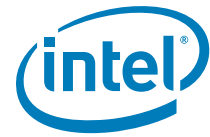

- SET MAX FREEZE LOCK
- SET MAX UNLOCK

6.1.6 48-Bit Address Command Set

The Intel X18-M/X25-M SATA SSDs support the 48-bit Address command set, which consists of

- FLUSH CACHE EXT
- READ DMA EXT
- READ NATIVE MAX ADDRESS EXT
- READ SECTOR(S) EXT
- READ VERIFY SECTOR(S) EXT
- SET MAX ADDRESS EXT
- WRITE DMA EXT
- WRITE MULTIPLE EXT
- WRITE SECTOR(S) EXT
- WRITE UNCORRECTABLE EXT

6.1.7 Device Configuration Overlay Command Set

The Intel X18-M/X25-M SATA SSDs support the Device Configuration Overlay command set, which consists of

- DEVICE CONFIGURATION FREEZE LOCK
- DEVICE CONFIGURATION IDENTITY
- DEVICE CONFIGURATION RESTORE
- DEVICE CONFIGURATION SET

6.1.8 General Purpose Log Command Set

The Intel X18-M/X25-M SATA SSDs support the General Purpose Log command set, which consists of

- READ LOG EXT
- WRITE LOG EXT

6.2 SATA Commands

The SATA 2.6 specification is a super set of the ATA/ATAPI-7 specification with regard to supported commands. The Intel X18-M/X25-M SATA SSDs support the following features that are unique to the SATA specification.

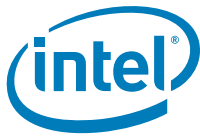

6.2.1 Software Settings Preservation

The Intel X18-M/X25-M SATA SSDs support the SET FEATURES parameter to enable/disable the preservation of software settings.

6.2.2 Native Command Queuing

The Intel X18-M/X25-M SATA SSDs support the Native Command Queuing (NCQ) command set, which includes

- READ FPDMA QUEUED
- WRITE FPDMA QUEUED

Note: With a maximum queue depth equal to 32.

6.2.3 Device Initiated Power Management (DIPM)

The Intel X18-M/X25-M SATA SSDs support the SET FEATURES parameter to enable Device Initiated Power Management.

7.0 References

This document references standards defined by a variety of organizations. Use the following list to identify the location of an organization's standards information.

Table 16. Standards References

Date or Rev. #	Title	Location
June 2009	Halogen Free (Applies to halogenated flame retardants and PVC in components)	Search for material description datasheet at http://intel.pcnalert.com
Dec 2008	VCCI	http://www.vcci.or.jp/vcci_e/general/join/index.html
June 2009	RoHS	Search for material description datasheet at http://intel.pcnalert.com
July 2007	SFF-8144, 1.8" drive form factor	http://www.sffcommittee.org
June 2007	Intel Rapid Storage Technology	http://support.intel.com/support/chipsets/ismm/
February 2007	Serial ATA Revision 2.6	http://www.sata-io.org
May 2006	SFF-8223, 2.5" Drive w/Serial Attachment Connector	http://www.sffcommittee.org
May 2005	SFF-8201, 2.5" drive form factor	http://www.sffcommittee.org
April 2004	ATA-6 spec	http://www.t13.org/project/d1410r3b-ATA-ATAPI-6.pdf
April 2004	ATA-7 Volume 1	http://www.t13.org/Documents/UploadedDocuments/docs2007/D1532v1r4b-AT_Attachment_with_Packet_Interface_-_7_Volume_1.pdf

**Table 16. Standards References (Continued)**

Date or Rev. #	Title	Location
1995 1996 1995 1995 1997 1994	International Electrotechnical Commission EN 61000 4-2 (Personnel Electrostatic Discharge Immunity) 4-3 (Electromagnetic compatibility (EMC)) 4-4 (Electromagnetic compatibility (EMC)) 4-5 (Electromagnetic compatibility (EMC)) 4-6 (Electromagnetic compatibility (EMC)) 4-11 (Voltage Variations)	http://www.iec.ch
1995	ENV 50204 (Radiated electromagnetic field from digital radio telephones)	http://www.iec.ch

8.0 Additional Product Information

For detailed information about the Intel X18-M/X25-M SATA SSD - 34 nm devices, please refer to the corresponding documentation.

Table 17. Related Documentation

Order Number	Title	Type
322319-003US	Intel® X18-M/X25-M SATA Solid State Drive - 34 nm Sightings Report	
322395-003US	Intel® X18-M/X25-M SATA Solid State Drive - 34 nm Errata Report	
320872-006US	Intel® High Performance SATA Solid-State Drives Product Selection Guide	

9.0 Terms and Acronyms

This document incorporates many industry- and device-specific words. Use the following list to define a variety of terms and acronyms.

Table 18. Glossary of Terms and Acronyms

Term	Definition
ATA	Advanced Technology Attachment
ATAPI	Advanced Technology Attachment Packet Interface
BER	Bit error rate, or percentage of bits that have errors relative to the total number of bits received
BIOS	Basic Input / Output System
Chipset	A term used to define a collection of integrated components required to make a PC function.

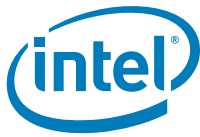
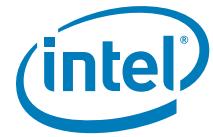

Table 18. Glossary of Terms and Acronyms (Continued)

Term	Definition
Device Initiated Link Power Management (DIPM)	The ability of the device to request SATA link power state changes.
DIPM	Device Initiated Power Management (SATA hard disk drive)
DMA	Direct Memory Access
DRAM	Dynamic Random Access Memory
EXT	Extended
FP	First Party
GB	Giga-byte defined as 1x10 ⁹ bytes. The total usable capacity of the Intel SSD may be less than the total physical capacity of the Intel SSD. This is due to the fact that a small portion of the Intel SSD capacity is used for NAND flash management and maintenance purposes.
HCI	Host Controller Interface
HCT	Hardware Compatibility Test
HDD	Hard Disk Drive
Host Initiated Link Power Management	The ability of the host to request SATA link power state changes.
Hot Plug	A term used to describe the removal or insertion of a SATA hard drive when the system is powered on.
IDEMA	International Disk Drive Equipment and Materials Association
IOPS	Input/output Operations Per Second
IMSM	Intel Matrix Storage Manager
LBA	Logical Block Address
LPM	Link Power Management: the ability of the SATA link layer to enter one of two lower power consuming states, partial and slumber
MB	Mega-bytes defined as 1x10 ⁶ bytes
MP	Multi-Processor
MTBF	Mean time between failure
Native Command Queuing (NCQ)	The ability of the SATA hard drive to re-order commands in order to maximize the efficiency of gathering data from the platters.
NOP	No Operation
NTFS	NT File System
OEM	Original Equipment Manufacturer
OS	Operating System
PIO	Programmable Input/Output
Port	The point at which a SATA drive physically connects to the SATA controller.
RAID	Redundant Array of Independent Disks
RMS	Root Mean Squared
RPM	Revolutions Per Minute
RTM	Release To Manufacture
SATA	Serial ATA
SFF	Small Form Factor
S.M.A.R.T.	Self-Monitoring, Analysis and Reporting Technology: an open standard for developing hard drives and software systems that automatically monitors a hard drive's health and reports potential problems.
SSD	Solid State Drive

Table 18. Glossary of Terms and Acronyms (Continued)

Term	Definition
TBD	To Be Determined
VCCI	Voluntary Control Council for Interface
WHQL	Microsoft* Windows Hardware Quality Labs
Write Cache	A memory device within a hard drive, which is allocated for the temporary storage of data before that data is copied to its permanent storage location.

10.0 Revision History

Date	Revision	Description
January 2010	005	Added new Model and Product code to front page
November 2009	004	Added "product codes" to the front page. Fixed description of word 217 in Table 15
October 2009	003	Updated sequential write numbers Updated Nonrecoverable read errors number Added support for DATA SET MANAGEMENT COMMAND Removed altitude information Misc document clean up
September 2009	002	Updated ordering information. Removed the "H" from the model numbers on title page to better align with actual product markings Added Related Documentation section
July 2009	001	Initial release.

